

Scasso installazione troppopieno

Overflow installation cutting

Piano spessore 20 mm - h.0

Plan thickness 30 mm - h.10 mm

Piano spessore 40 mm - h.20 mm

Plan thickness 50 mm - h.30 mm

Piano spessore 60 mm - h.40 mm

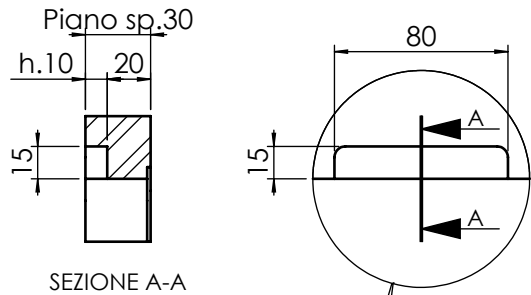

Installazione filotop

foro incasso: 370x430 R10 mm

abbassamento filotop:

381x441x1,5 R11 mm

base 450 mm

Flush installation

built-in fitting hole:

370x430 R10 mm

filotop lowering:

381x441x1,5 R11 mm

cabinet 450 mm

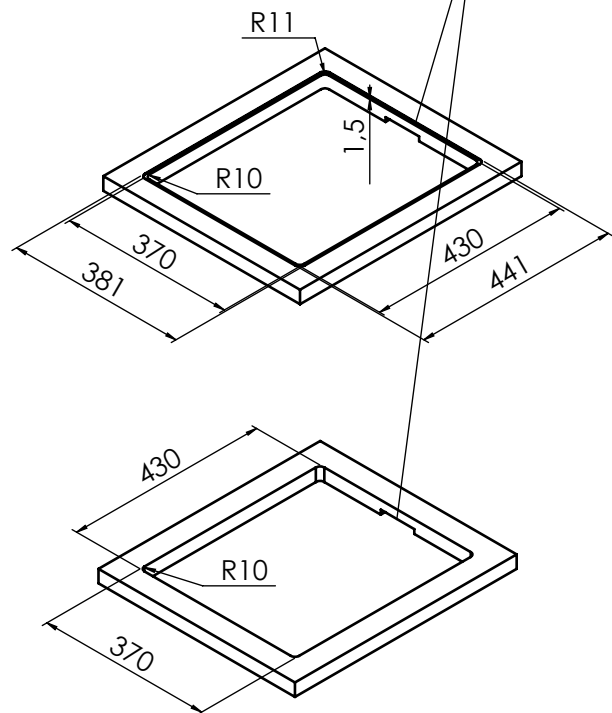

Installazione slim

foro incasso:

370x430 R10 mm

base 450 mm

Flat-mounted installation

built-in fitting hole:

370x430 R10 mm

cabinet 450 mm

Installazione sottotop

foro sottotop: 340x400 R12 mm

n°8 fori \varnothing 10 mm prof.15 mm base 500 mm

Undermounted installation

undertop fitting hole: 340x400 R12 mm

n°8 holes \varnothing 10 mm depth 15 mm cabinet 500 mm

