

INSTALLAZIONE: Slim

MODELLO: IRIDE MATT

45 x 45	Base 500 Foro incasso: 430 x 430	Base 500 Fitting hole: 430 x 430
---------	-------------------------------------	-------------------------------------

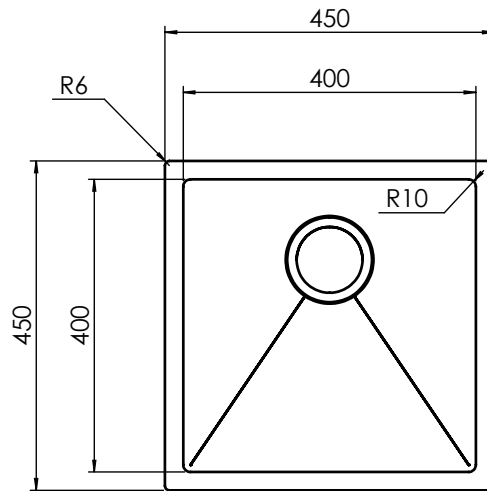

INSTALLAZIONE: Sottotop

MODELLO: IRIDE MATT

45 x 45	Base 600 Foro sottotop: 400 x 400 R10	Base 600 Fitting hole: 400 x 400 R10
---------	--	---

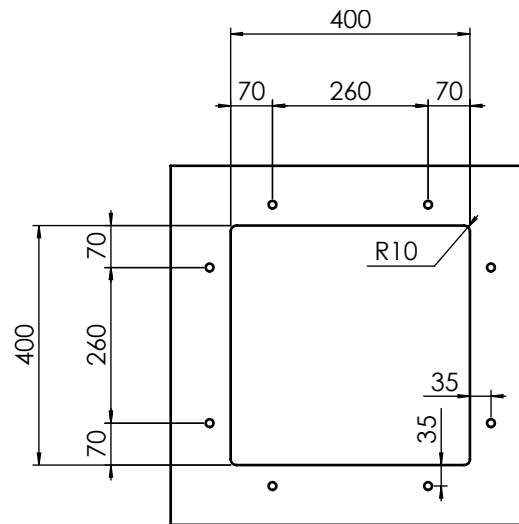

8 fori \varnothing 13 mm
profondità 15 mm

8 holes, each \varnothing 13 mm
depth 15 mm

INSTALLAZIONE: Filotop

MODELLO: IRIDE MATT

45 x 45	Base 500 Foro filotop: 430 X 430	Base 500 Fitting hole: 430 X 430
---------	-------------------------------------	-------------------------------------

