

INSTALLAZIONE: Sottotop

MODELLO: CINZIA SOTTOTOP

50 x 40 R80	Base 800 Foro sottotop: 500 x 400 R80	Base 800 Undertop hole: 500 x 400 R80
-------------	--	--

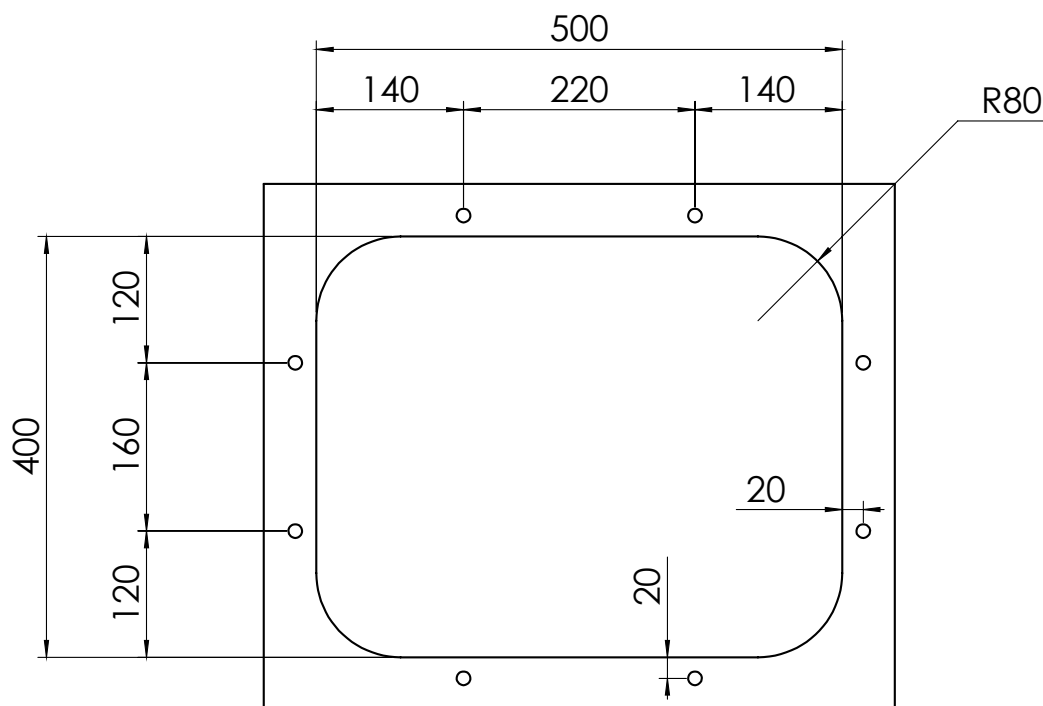
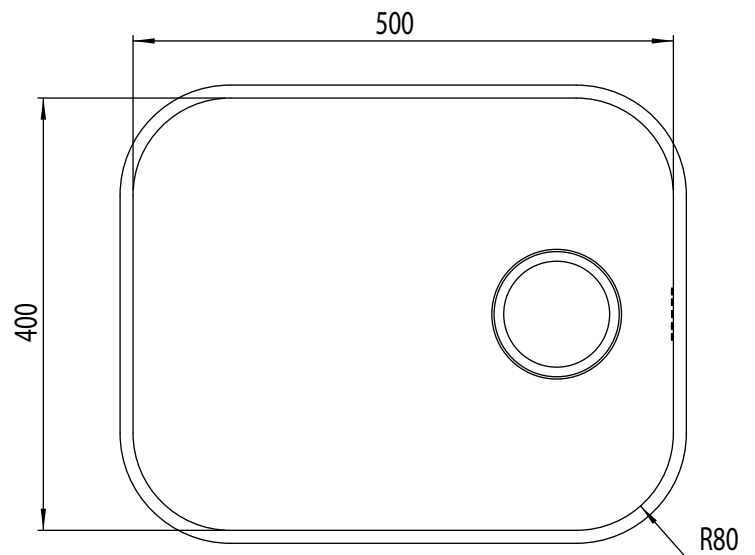

N° 8 fori \varnothing 13 mm profondità 15 mm

8 holes, each \varnothing mm 13 depth 15