

INSTALLAZIONE: Sottotop

MODELLO: CINZIA SOTTOTOP

40 x 40 R60	Base 600 Foro sottotop: 400 x 400 R60	Base 600 Undertop hole: 400 x 400 R60
-------------	--	--

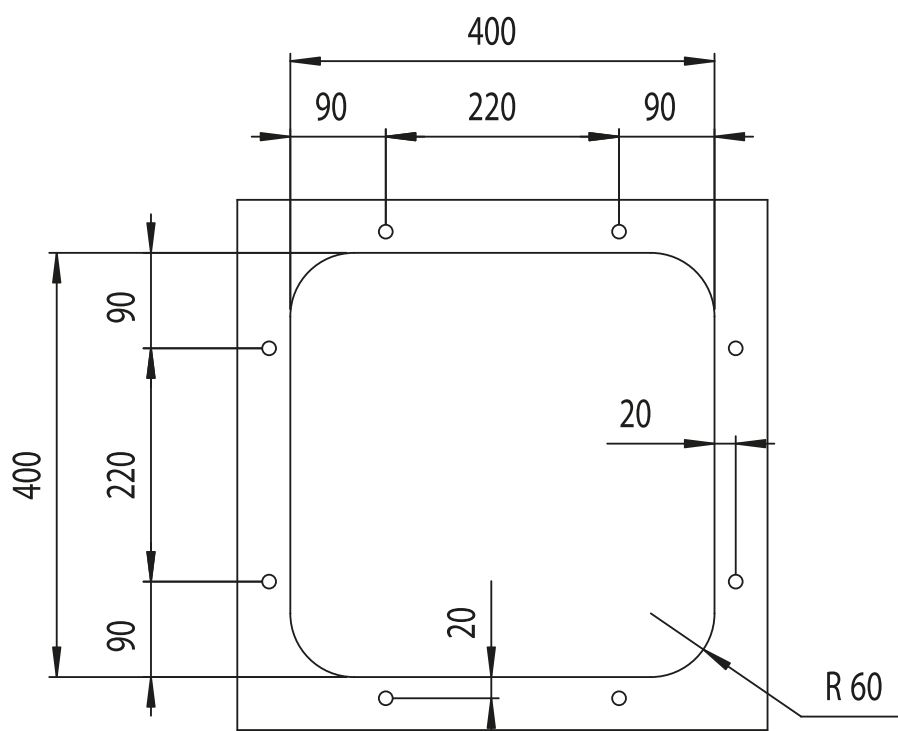
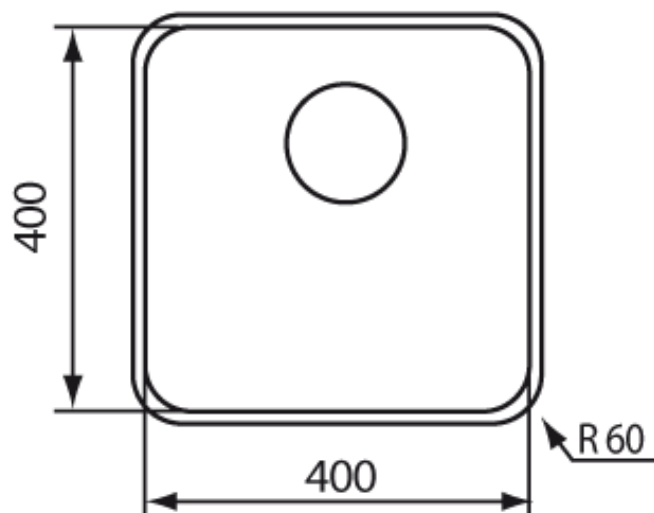

N° 8 fori \varnothing 13 mm profondità 15 mm

8 holes, each \varnothing mm 13 depth 15