

### Installazione slim

foro incasso:  
735x495 R10 mm  
base 800 mm

*Flat-mounted installation  
built-in fitting hole:  
735x495 R10 mm  
cabinet 800 mm*

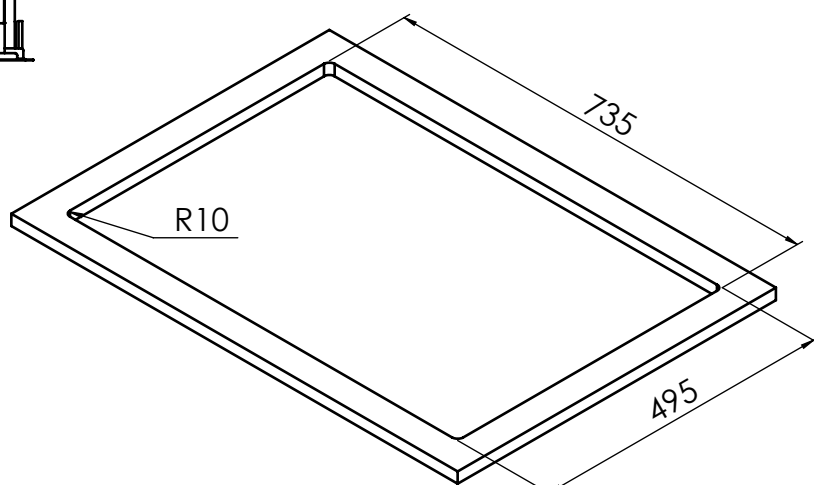

### Installazione filotop

foro incasso: 735x495 R10 mm  
abbassamento filotop:  
751x511x1,5 R11 mm  
base 800 mm

*Flush installation  
built-in fitting hole:  
735x495 R10 mm  
filotop lowering:  
751x511x1,5 R11 mm  
cabinet 800 mm*

